

## LED WATERPROOF CYCLONE IP66 TW

### KEY FEATURES

- High-end Professional IP66 Waterproof fixture with robust design
- Samsung LED chips with a long lifetime of 76,000 hours
- Premium Osram or Tridonic LED Driver
- 3x2.5mm<sup>2</sup> and fast connectors at 2 ends for a quick (toolless) installation
- Including stainless steel clips INOX
- 130+ lumen per watt
- Applicable in extreme conditions due to aluminum housing

### APPLICATIONS



### OPTIONS



3,000K

5,000K



### SPECIFICATIONS

Item code	Description	W	Im	lm/W	Kelvin	CRI	Input current	Lifetime L80B10	Equivalent	Beam angle
4605050	LED Waterproof Cyclone IP66 23W 1200 4000K Incl. 3x2.5mm TW	23	3,000	130	4,000	≥80	0.12A	76,000	2x36W FL	120°
4605043	LED Waterproof Cyclone IP66 30W 1200 4000K Incl. 3x2.5mm TW	30	4,000	133	4,000	≥80	0.15A	76,000	2x36W FL	120°
4605036	LED Waterproof Cyclone IP66 38W 1200 4000K Incl. 3x2.5mm TW	38	5,000	132	4,000	≥80	0.19A	76,000	2x58W FL	120°
4605029	LED Waterproof Cyclone IP66 42W 1200 4000K Incl. 3x2.5mm TW	42	6,000	143	4,000	≥80	0.2A	76,000	2x58W FL	120°
4605012	LED Waterproof Cyclone IP66 49W 1200 4000K Incl. 3x2.5mm TW	49	7,000	143	4,000	≥80	0.24A	76,000	2x58W FL	120°
4605005	LED Waterproof Cyclone IP66 56W 1200 4000K Incl. 3x2.5mm TW	56	8,000	143	4,000	≥80	0.27A	76,000	2x80W FL	120°
4604992	LED Waterproof Cyclone IP66 76W 1500 4000K Incl. 3x2.5mm TW	76	10,000	132	4,000	≥80	0.36A	76,000	2x80W FL	120°

### TECHNICAL DATA

Electrical data	
Voltage (V)	220-240
Frequency (Hz)	50/60
Power factor (λ)	≥0.95
Operating mode	Integrated LED Driver
Electrical connection	Max 3x2,5 mm <sup>2</sup> wire
Total harmonic distortion	≤ 20 %

Certificates & standards	
Driver certificates	CE/ENEC
Fixture certificates	CE
Ingress protection	IP66
Protection class	I
Protection class IK	10
Glow Wire Test ( IEC 695-2-1)	850°C
Photobiological safety group EN62778	RG0

# LED WATERPROOF CYCLONE IP66 TW

## Temperatures & operating conditions

Ambient temperature	25°C
Operating temperature	-25 ~ +45°C
Storage temperature	-40 ~ +85°C

## Colors & materials

Color ( Housing)	Grey RAL7016
Material ( Housing)	Aluminum
Material ( Diffuser)	PC

## Capabilities

UGR	≤25-30
Dimmable	No
Type of connection	Push Terminal, 3-pole
LED Module replacable	No
Installation	Through-wiring Possible

## SPECIFICATIONS DRIVERS

Item code	Description	Driver failure rate at 5,000h	Inrush current Ipeak	Inrush current Twidth	Max. No. of drivers on MCB Type B 10A	Max. No. of drivers on MCB Type B 16A	Max No.of drivers on MCB Type C 10A	Max. No. of drivers on MCB Type C 16A
4605050	LED Waterproof Cyclone IP66 23W 1200 4000K Incl. 3x2.5mm TW	≤1%	30A	200µs	12	19	20	32
4605043	LED Waterproof Cyclone IP66 30W 1200 4000K Incl. 3x2.5mm TW	≤1%	30A	200µs	12	19	20	32
4605036	LED Waterproof Cyclone IP66 38W 1200 4000K Incl. 3x2.5mm TW	≤1%	30A	200µs	12	19	20	32
4605029	LED Waterproof Cyclone IP66 42W 1200 4000K Incl. 3x2.5mm TW	≤1%	30A	200µs	12	19	20	32
4605012	LED Waterproof Cyclone IP66 49W 1200 4000K Incl. 3x2.5mm TW	≤1%	30A	200µs	12	19	20	32
4605005	LED Waterproof Cyclone IP66 56W 1200 4000K Incl. 3x2.5mm TW	≤1%	30A	200µs	12	19	20	32
4604992	LED Waterproof Cyclone IP66 76W 1500 4000K Incl. 3x2.5mm TW	≤1%	≤40A	220µs	8	13	13	22

## DIMENSIONS

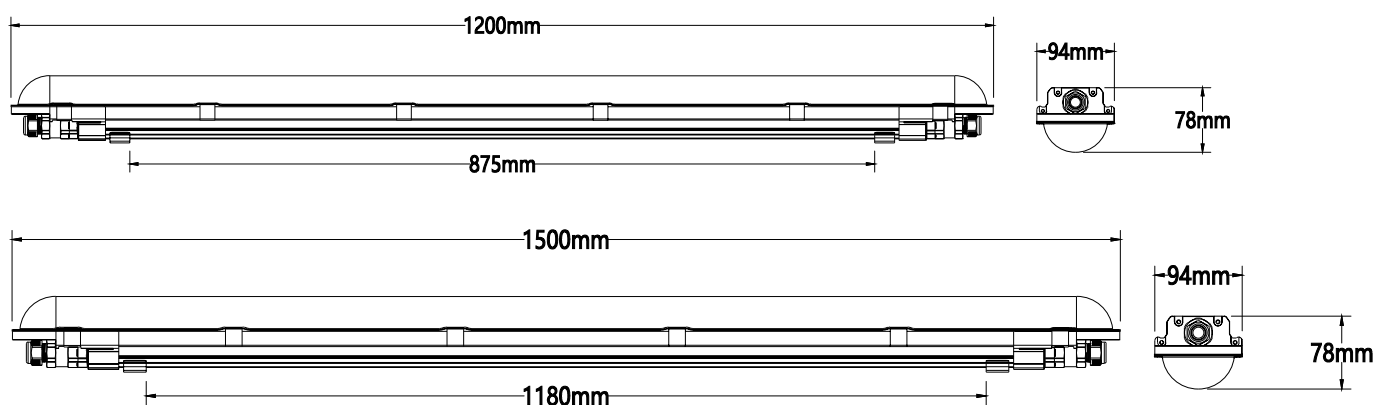

## PRAGMALUX

All rights reserved. Pragmalux - PDL Lighting Group B.V. retains the right to modify product specifications without any prior notice or obligation and does not assume any liability for any consequences of using this document. Subject to errors and printing errors. Luminous flux tolerance: +/- 10%. Power consumption tolerance: +/- 10%.

Version: December 2019

Page 2/4

# LED WATERPROOF CYCLONE IP66 TW

## ACCESSORIES



Triangle hook



Adjustable suspension cable



External IP65 Sensor

## PHOTOMETRIC SPECIFICATIONS

### LED Waterproof Cyclone IP66 23W 1200 4000K

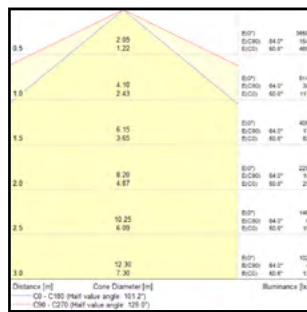
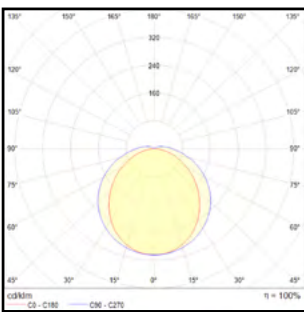

### LED Waterproof Cyclone IP66 30W 1200 4000K

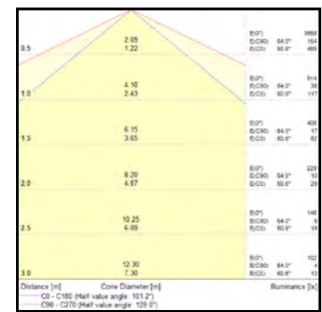
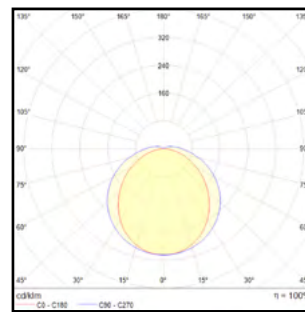

### LED Waterproof Cyclone IP66 38W 1200 4000K

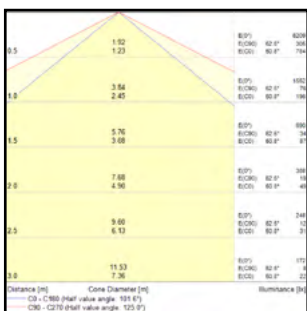
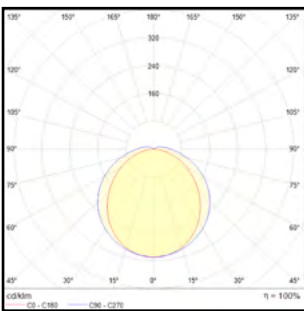

### LED Waterproof Cyclone IP66 42W 1200 4000K

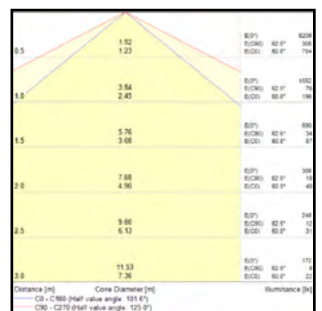
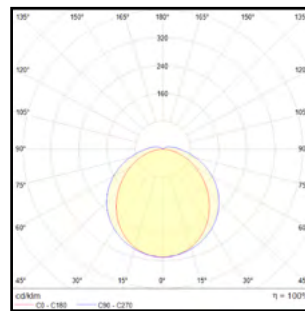

### LED Waterproof Cyclone IP66 49W 1200 4000K

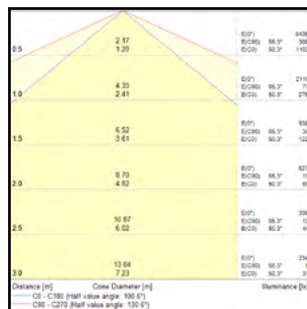
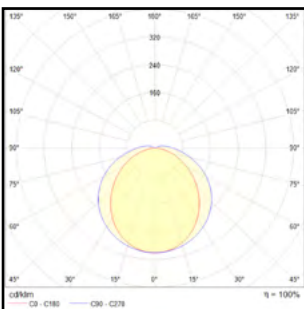

### LED Waterproof Cyclone IP66 56W 1200 4000K

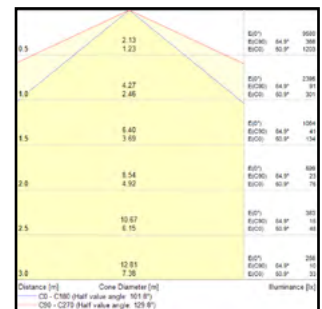
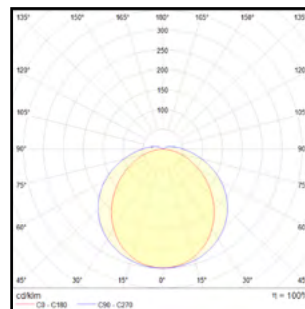

## PRAGMALUX

All rights reserved. PragmaLux - PDL Lighting Group B.V. retains the right to modify product specifications without any prior notice or obligation and does not assume any liability for any consequences of using this document. Subject to errors and printing errors. Luminous flux tolerance: +/- 10%. Power consumption tolerance: +/- 10%.

Version: December 2019

# LED WATERPROOF CYCLONE IP66 TW

## LED Waterproof Cyclone IP66 76W 1500 4000K

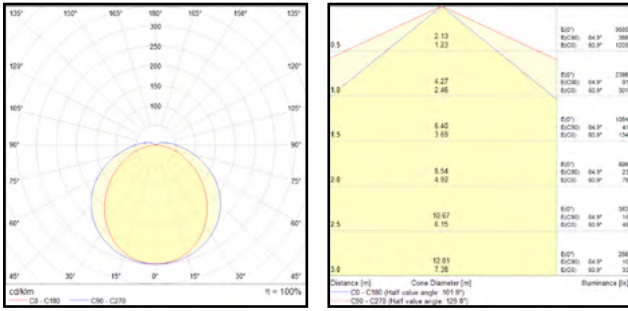

## PACKAGING INFORMATION

Item code	Description	Single box		Master carton		
		Dimensions(LxWxH) (mm)	Weight(kg)	Units per master carton	Dimensions(LxWxH) (mm)	Weight(kg)
4605050	LED Waterproof Cyclone IP66 23W 1200 4000K Incl. 3x2.5mm TW	1210x100x90	3.45	4	1225x240x220	13.8
4605043	LED Waterproof Cyclone IP66 30W 1200 4000K Incl. 3x2.5mm TW	1210x100x90	3.45	4	1225x240x220	13.8
4605036	LED Waterproof Cyclone IP66 38W 1200 4000K Incl. 3x2.5mm TW	1210x100x90	3.45	4	1225x240x220	13.8
4605029	LED Waterproof Cyclone IP66 42W 1200 4000K Incl. 3x2.5mm TW	1210x100x90	3.45	4	1225x240x220	13.8
4605012	LED Waterproof Cyclone IP66 49W 1200 4000K Incl. 3x2.5mm TW	1210x100x90	3.45	4	1225x240x220	13.8
4605005	LED Waterproof Cyclone IP66 56W 1200 4000K Incl. 3x2.5mm TW	1210x100x90	3.45	4	1225x240x220	13.8
4604992	LED Waterproof Cyclone IP66 76W 1500 4000K Incl. 3x2.5mm TW	1510x100x90	4	4	1550x240x220	16

## APPLICATIONS

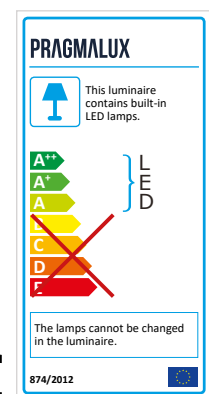

## PRAGMALUX

All rights reserved. Pragmalux - PDL Lighting Group B.V. retains the right to modify product specifications without any prior notice or obligation and does not assume any liability for any consequences of using this document. Subject to errors and printing errors. Luminous flux tolerance: +/- 10%. Power consumption tolerance: +/- 10%.

Version: December 2019